





REMOTE CONTROL 1-WAY MOTORCYCLE ALARM SYSTEM FORCE 1

Operation manual



Please read the manual before use

1-Way Motorcycle alarm system

Function Key

- Arm: 
- Disarm: 
- Mute Arm: 
- Remote Start Engine: 

Function Operation

- 1. Arm:** Press the button  once, the siren would beep once, the alarm system is in ARM mode. If move the motorcycle or ignition on, the siren will sound and the direction lights will flash, the engine will be locked at the same time.
- 2. Disarm:** Press the button  once, the siren would give 2 beeps, the lights would flash twice, the motorcycle is in the DISARM status.

3. Mute Arm: press the button  , the direction light would flash once, the alarm system is in MUTE ARM mode. If the motorcycle is touched , the siren would keep silent. The direction light would flash and the engine will be cut off; if the key in the key lock is on, the siren will sound at once.

4. Remote Start Engine: Press the button  twice within 3s to start the engine . After starting the engine by remote controller, the engine will be on until you stop it by remote controller. You can drive the motorcycle without using the key.

5. Adjust Sensitivity: Adjust the sensitivity on the mainframe by hand, turn clockwise to increase sensitivity, turn anti-clockwise to decrease sensitivity. The sensitivity has been adjusted well when leaving factory.

6. Remote Cut off Engine: When the engine is running, press the button  twice within 3s to kill engine. (Please kindly note that remote starting engine is to remote killing engine.)

7. Anti-robbery and assistance: When the motorcycle is robbed and driven away, the owner-driver can stop it by pressing the button  twice within 3s, the siren will sound urgently and the direction lights will flash at the same time.

2

8. Code Learning: In disarm mode, put the motorcycle key in the key lock and turn it from ACC OFF to ACC ON, 3 times in 5s, when the lights flash and the siren beeps once, press any button on the remote controller in 10s, the direction lights will flash once, it means the system learn the Code of the remote controller. The other remote controller can be learnt code in the same way. (The code has been learnt well before leaving factory, the user need not learn it again if unnecessary.)

Remark: one mainframe could learn at most two remote controllers once.

9. Emergent disarming: If remote controller is lost, the driver need to turn key ON/OFF 8 times within 8s, and disable the system.

10. LED Memory (optional)

In normal conditions: flashes twice;

Malevolent offense condition: flashes three times;

Attempt to start motorcycle without disarming: flashes continuously.

3

Anti-theft main engine and common vehicle distribution wire function contrast form

Vehicle Wire	Mainframe Wire Color	HONDA Wire Color	SANYANG Wire Color	YAMAHA Wire Color	SUZUKI Wire Color
12v(+)	Red	Red	Red	Red	Red
12v(-)	Black	Green	Green	Black	Black/White
Key on+12v	Orange	Black	Black	Brown	Orange
Start Wire	Blue	Yellow/Red	Yellow/Red	Blue/White	Black/White
Ignition off (Up)	Pink	Black and White(Up)	Black and White(Up)	Black and White(Up)	(Remark1)
Ignition off (Down)	Gray	Black and White (Down)	Black and White (Down)	Black and White (Down)	
Direction Light	Yellow	Lighte Blue	Light Blue	Deep Brown	Black
Direction Light	Yellow	Orange	Orange	Deep Green	Green

Remork(1): Low voltage auto tester is suggested to test which terminal is for turning off the engine.

4

Circuit diagrams of installing main unit of the system

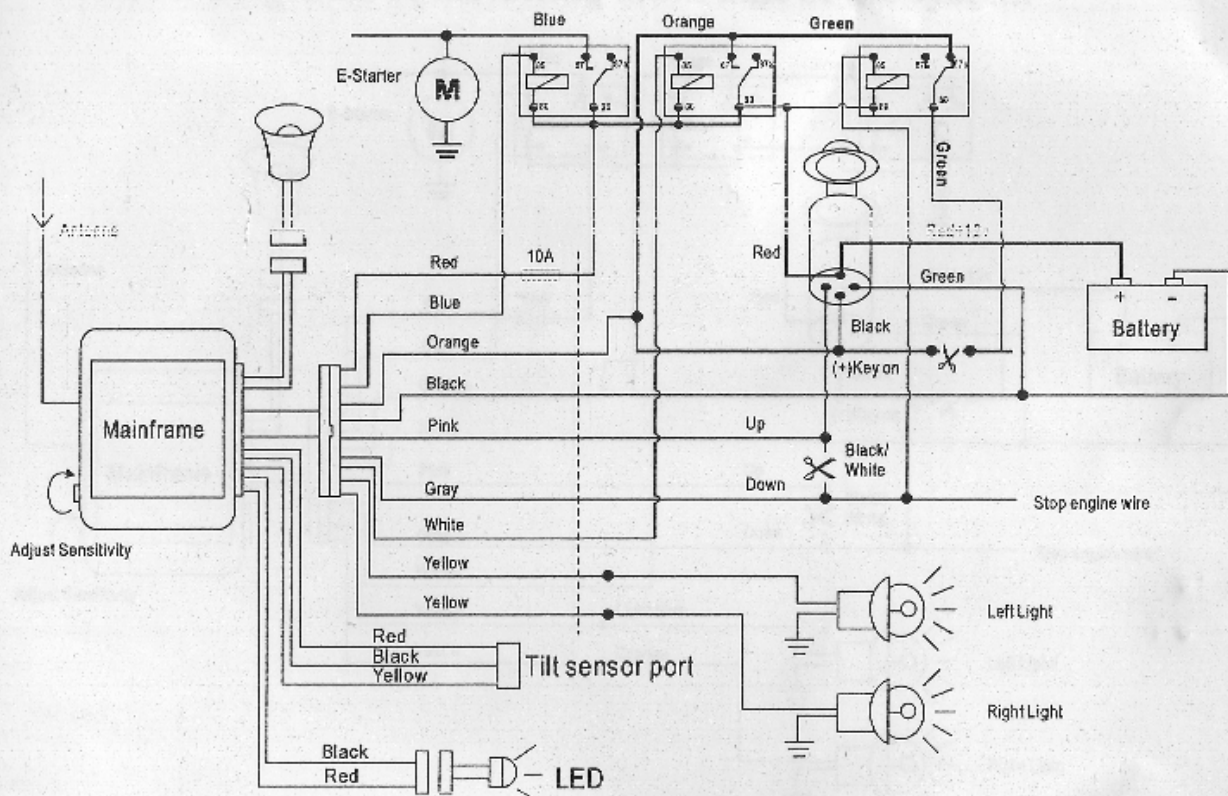

5